

PROTECCIÓN ELÉCTRICA

**CATÁLOGO
2017
TARIFA**

APARELEC

SISTEMA D0

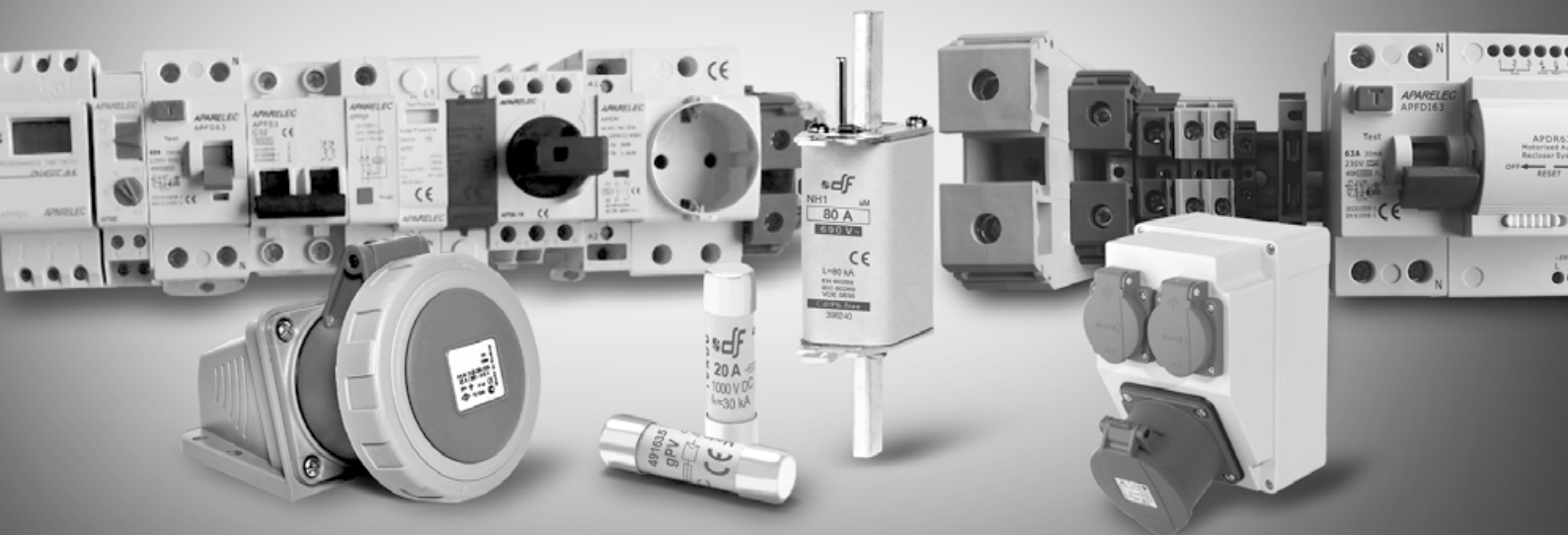

BASES DO CERÁMICAS



TAMAÑOS	In (A)	POLOS	CONEXIÓN	UD. CAJA	FIJACIÓN	REFERENCIA
DO 1	16	1P	Tornillo-Tornillo	20	Rail Din	310.111.BN
			Tornillo-Tornillo		Tornillo	310.121.BN
		3P	Tornillo-Tornillo	5	Rail Din	310.211.BN
			Tornillo-Tornillo		Tornillo	310.221.BN
DO 2	63	1P	Brida-Brida	20	Rail Din	311.112.BN
			Brida-Brida		Tornillo	311.122.BN
		3P	Brida-Brida	5	Rail Din	311.212.BN
			Brida-Brida		Tornillo	311.222.BN
DO 3	100	1P	Brida-Brida	5	Rail Din	312.113.BN
			Brida-Borne 50 1P		Rail Din	312.PB.1PC
			Brida-Brida		Tornillo	312.123.BN
			Brida-Borne 50 1P		Tornillo	312.TB.1PC
			Brida-Pletina		Pletina	312.133.BN

BASES DO TERMOPLÁSTICAS



TAMAÑOS	In (A)	POLOS	CONEXIÓN	UD. CAJA	FIJACIÓN	REFERENCIA
DO 2	63	1P	Brida-Pletina	125	Pletina	311.132.TP
DO 3	100	1P	Brida-Pletina	10	Pletina	312.133.BP
			Brida-Brida	10	Rail Din	312.113.TP
			Brida-Borne 50 1P	10	Rail Din	312.PTP1P
			Brida-Brida	10	Tornillo	021214
			Brida-Borne 50 1P	10	Tornillo	021215

TAPONES ROSCADOS DO

TAMAÑOS	In (A)	ROSCA	UD. CAJA	REFERENCIA
DO 1	16	E 14	20	315.11.TBN
DO 2	63	E 18	20	316.11.TBN
DO 3	100	M 30	10	317.11.TBN

TAPAS PROTECTORAS DO

TAMAÑOS	In (A)	POLOS	UD. CAJA	REFERENCIA
DO 1 / DO 2	16 / 63	1P	20	331.TABN19
DO 3 1 ALA	100	1P	20	332.TALA19
DO 3 2 ALAS	100	1P	20	332.TABN19
DO 1 / DO 2	16 / 63	3P	20	333.TABN19



DO 1 16A 400V

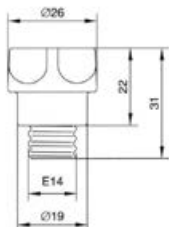

DO 2 63A 400V

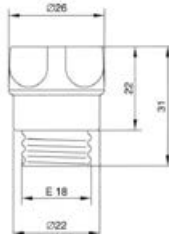

DO 3 100A 400V

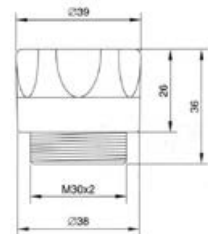

ANILLOS DE AJUSTE DO



TAMAÑOS	In (A)	UD. CAJA	REFERENCIA
DO 1	2	10	300AAJ002N
DO 1	4	10	300AAJ004N
DO 1	6	10	300AAJ006N
DO 1	10	10	300AAJ010N
DO 2	20	10	301AAJ020N
DO 2	25	10	301AAJ025N
DO 2	35	10	301AAJ035N
DO 2	50	10	301AAJ050N
DO 3	80	10	302AAJ080N

ANILLOS DE ADAPTACIÓN DO
(PARA COLOCACIÓN FUSIBLES DO 1 EN BASE DO 2)

TAMAÑOS	In (A)	UD. CAJA	REFERENCIA
DO 1	2	10	300AAD002N
DO 1	4	10	300AAD004N
DO 1	6	10	300AAD006N
DO 1	10	10	300AAD010N
DO 1	16	10	300AAD016N



MUELLE DE ADAPTACIÓN DO
(PARA COLOCACIÓN FUSIBLES DO 1 EN TAPONES DO 2)

TAMAÑOS	In (A)	UD. CAJA	REFERENCIA
DO 1	2 - 16	10	300MADAPTA

Base D01 16A 400V~

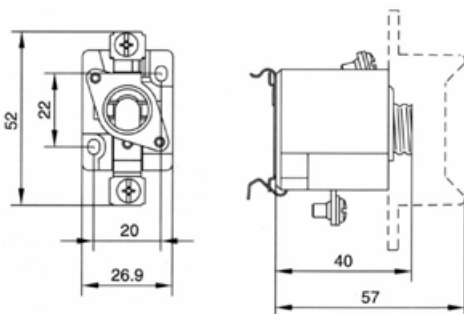

Base D03 100A 400V~

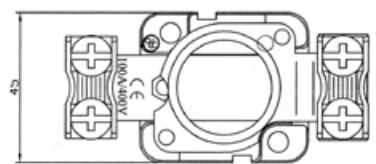

Base D02 63A 400V~

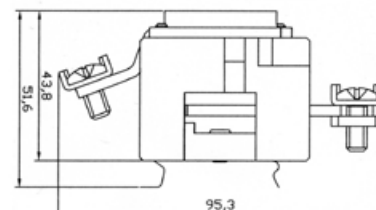
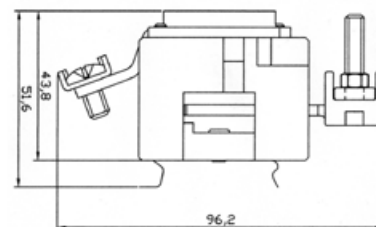
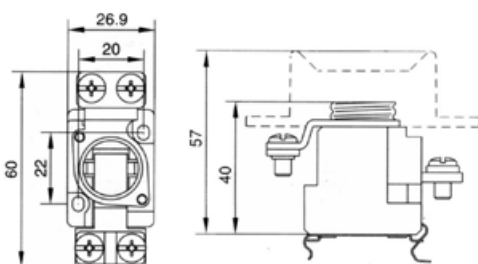

SISTEMA DO

CONDICIONES GENERALES DE VENTA

PEDIDOS MÍNIMOS

Pedidos mínimos de 100 € netos.

PRECIOS

Se aplicarán los precios y descuentos vigentes en el momento de formalizar el pedido.

EMBALAJES

La mercancía se suministra en los envases estándar completos indicados.

PORTES

Península

**100 € - 399 € (opcional 9 € cargados en factura)
+ 400 € (portes pagados)**

Baleares

**100 € - 599 € (opcional 18 € cargados en factura)
+ 600 € (portes pagados)**

Canarias, Ceuta y Melilla

+ 1.000 € (portes pagados)

DEVOLUCIONES

Toda devolución y condiciones deberán ser aceptadas previamente por APARELEC BCN, S.L., y comunicada antes de 15 días posteriores a su recepción.

PLAZO DE ENTREGA

El requerido por el comprador.

En caso contrario se considerará 7 días desde la recepción del pedido.

CONDICIONES GENERALES

APARELEC BCN, S.L., se reserva el derecho de modificar los precios y/o las características técnicas de los productos de esta tarifa sin previo aviso.

***APARELEC* BCN, S.L.**

C/ Cobalt, 28

08940 Cornellá de Llobregat (Barcelona)

T. 934 753 470 · F. 934 800 580

aparelecbcn@aparelecbcn.com

www.aparelecbcn.com